

Let your productivity flow

Perform at your peak with
a Fellowes Monitor Arm



reddot winner 2022



Fellowes

walters.



Glide through your to-do list in comfort

When we're in a flow state, incredible things happen. We become totally immersed, able to fly through activities without being distracted. Time seems to pass unnoticed as we achieve more. Can you imagine if every day we could be in that flow state? A Fellowes Monitor Arm makes it possible, by helping you accomplish tasks faster, easier and in heightened ergonomic comfort. Allowing you to perform at your peak, however you wish to work.

In a 2021 survey*, 48% of participants said that relieving neck pain would make their workspace healthier for them. Using a Fellowes monitor arm means that you can set your screen to the exact height and angle to improve your health when working. This reduces the risk of neck pain and allows for more comfortable, productive working.

Fellowes 100-year wealth of research and product development in the office workspace has resulted in a monitor arm and accessories range designed to allow effortless adjustment for full workspace flexibility, with configurations and added features to suit all individual work styles.

*Survey data collected by Censuswide for Fellowes, 2021



FIRA Compliance

FIRA International are an independent Ergonomic Standards Accreditor.

This logo signifies that the relevant product complies with EU Health and Safety Legislation: BS EN ISO 9241 Ergonomic requirements for office work with visual display terminals (VDT's): Part 5: 1999, workstation layout and postural requirements.

All Fellowes monitor arms are FIRA accredited.

*Excludes wall mount options



Choosing the right Monitor Arm

Your workspace needs to work for you. The extensive range of Fellowes Monitor Arms and accessories means there is a solution for everyone. Finding the right specification for you is easy, simply follow the QR code to use Fellowes' Interactive Monitor Arm Selector Tool.



Things to think about

1. Number of screens

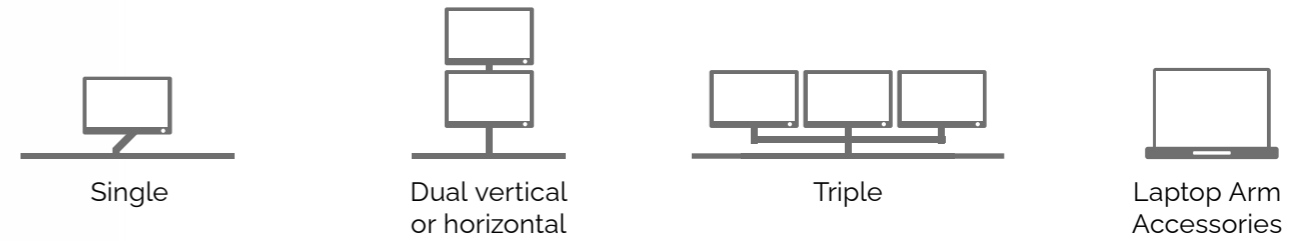

2. Mounting option

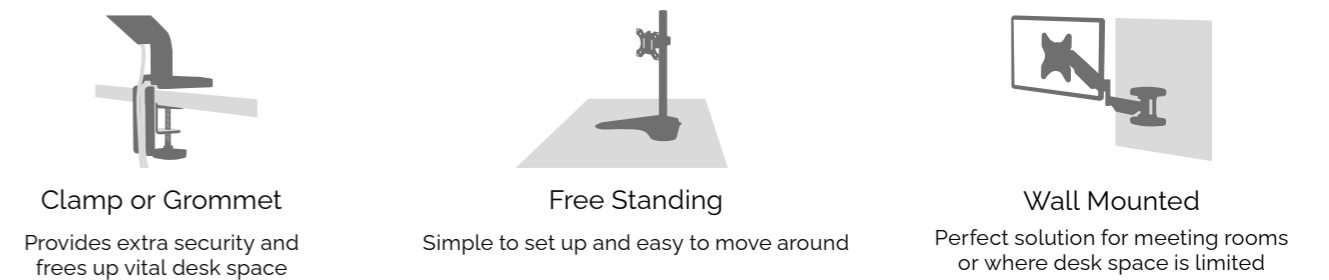

3. Level of movement

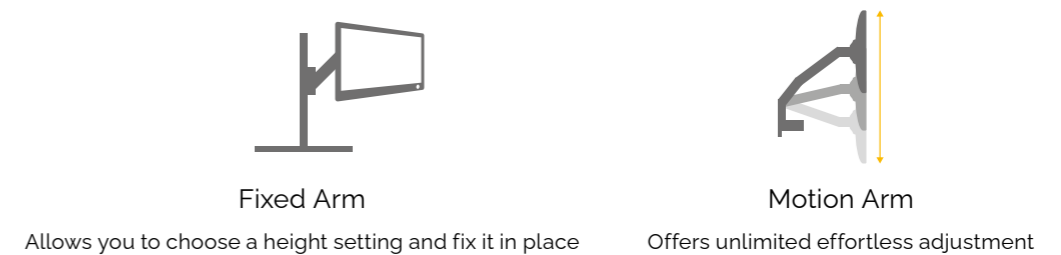

4. Adjustability

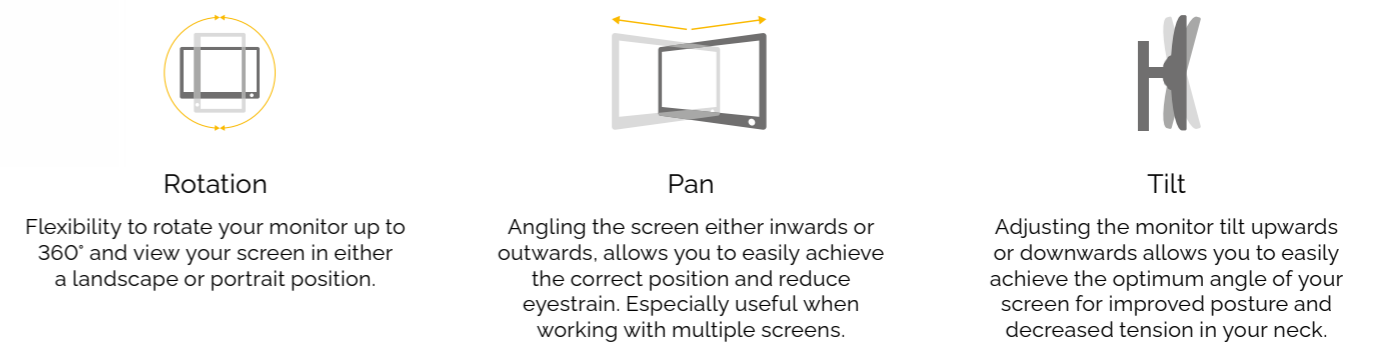

5. VESA Compliance



Most monitors have a VESA hole pattern on the back of the screen. VESA stands for Video Electronic Standard Association and is the industry benchmark used by worldwide manufacturers of flat screen monitors.

Fellowes mounting solutions are all designed to fit these various VESA standards.



reddot winner 2022



Tallo™ &

Tallo Modular™

Perfect
Harmony

Our most sophisticated range of monitor arms,
expertly crafted to perform effortlessly

Tallo™ not only reimagines how a monitor arm can facilitate productive work, but enriches it through human-centered design. Modern in appearance, robust in performance, Tallo™ makes any desk a productive space for comfortable, meaningful work.



How Tallo™ works

Choose a configuration to suit your needs from a mixture of fixed and gas spring arm options.

Fixed and motion arms

Fixed arms provide additional reach and movement as well as being a cost effective solution where regular height adjustment is not required. Motion arms deliver effortless gas spring height adjustment, great for hot desking and collaborative working.

Sliders

Sliders allow you to increase the size of screens an arm can hold whilst enabling you to place screens seamlessly side by side. This helps to save valuable desk space and maintain an ergonomic working position.

Seamless
Adjustment

Ergonomic **excellence**

Experience perfect harmony

S = Slider

Provides seamless monitor alignment and increases the maximum screen size the arm can hold

M – Motion Arm (gas spring)

Provides dynamic effortless height adjustability

F = Fixed Arm

Increases reach, height and movement range



Tallo Configurations

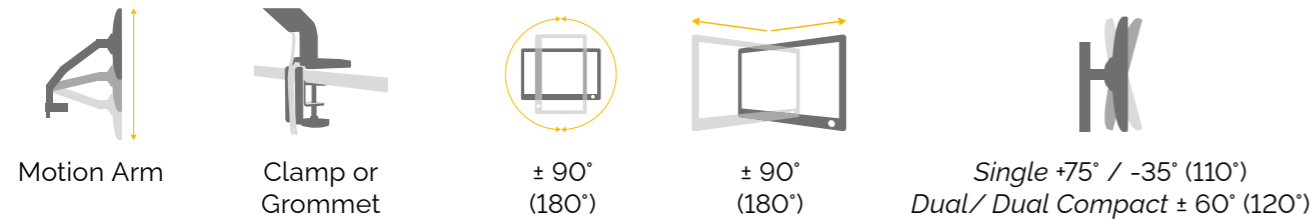

	Tallo™ Single	Tallo™ Dual	Tallo™ Dual Compact
Code	Silver: 8613001	Silver: 8613101	Silver: 8613201
	Black: 8614301	Black: 8614401	Black: 8614501
	White: 8614601	White: 8614701	White: 8614801
Product Dimensions (H x W x D)	130 x 375 x 320 mm	145 x 570 x 430 mm	150 x 660 x 320 mm
Product Weight	3.6 kg	6.9 kg	5.8 kg
Height Adjustment Range	178 - 500 mm	178 - 500 mm	0 - 482 mm
Dynamic Height Adjustability	322 mm		
Pole Height	-	-	200 mm
Reach Range	74 - 619 mm	120 - 667 mm	120 - 446 mm
Rotation	± 90° (180°)		
Pan	± 90° (180°)		
Tilt	+ 75° / - 35° (110°)	± 60° (120°)	
Arm Swivel	360° / 180° Lockout feature	270° / 180° Lockout feature	270° / 180° Lockout feature
VESA	75 x 75 / 100 x 100		
Clamp: Desk Thickness	0 - 45 mm		
Grommet: Desk Thickness / Diameter	10 - 75 mm / 10 - 80 mm		
Tension Adjustment	Yes		
Weight Capacity: Per Screen (kg)	1 - 9 kg		
Maximum Monitor Size (diagonal)	40" (101.6 cm)	40" (101.6 cm)	40" (101.6 cm)
Maximum Monitor Size (W x H)	100 cm (H)	144 x 100 cm	103 x 96 cm
Warranty	15 years		

Tallo Modular Single Configurations

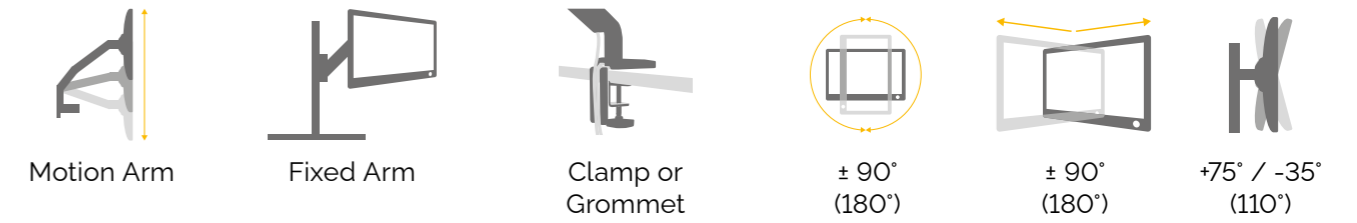

	1F	1FF	1M	1FM
Code	White: 8615901	White: 8616001	White: 8616201	White: 8616101
	Black: 8614901	Black: 8615001	Black: 8615201	Black: 8615101
	Silver: 8613301	Silver: 8613401	Silver: 8613601	Silver: 8613501
Product Dimensions (H x W x D)	100 x 550 x 250 mm	100 x 540 x 312 mm	100 x 505 x 140 mm	100 x 555 x 320 mm
Product Weight	3.3 kg	4.0 kg	3.7 kg	4.4 kg
Height Adjustment Range	166 - 603 mm	250 - 673 mm	0 - 772 mm	0 - 852 mm
Dynamic Height Adjustability	-	-	322 mm	322 mm
Pole Height	510mm			
Reach Range	74 - 373 mm	74 - 628 mm	74 - 432 mm	74 - 687 mm
Rotation	± 90° (180°)			
Pan	± 90° (180°)			
Tilt	+ 75° / - 35° (110°)			
Arm Swivel	270°			
VESA	75 x 75 / 100 x 100			
Clamp: Desk Thickness	0 - 45 mm			
Grommet: Desk Thickness / Diameter	10 - 75 mm / 10 - 80 mm			
Tension Adjustment	No	No	Yes	Yes
Weight Capacity: Per Screen (kg)	1 - 9 kg			
Maximum Monitor Size (diagonal)	40" (101.6 cm)	40" (101.6 cm)	40" (101.6 cm)	40" (101.6 cm)
Maximum Monitor Size (H)	121 cm	135 cm	154 cm	170 cm
Warranty	15 years			

Tallo Modular Dual Configurations



	2FS	2FFS	2MS	2FMS
Code	White: 8616301	White: 8616401	White: 8616601	White: 8616501
	Black: 8615301	Black: 8615401	Black: 8615601	Black: 8615501
	Silver: 8613701	Silver: 8613801	Silver: 8614001	Silver: 8613901
Product Dimensions (H x W x D)	160 x 550 x 255 mm	155 x 610 x 374 mm	150 x 660 x 320 mm	155 x 620 x 365 mm
Product Weight	5.7 kg	8.3 kg	4.6 kg	7.9 kg
Height Adjustment Range	188 - 623 mm	250 - 673 mm	0 - 791 mm	0 - 871 mm
Dynamic Height Adjustability	-	-	322 mm	322 mm
Pole Height	510 mm			
Reach Range	120 - 450 mm	120 - 705 mm	120 - 446 mm	120 - 764 mm
Rotation	± 90° (180°)			
Pan	± 90° (180°)			
Tilt	± 60° (120°)			
Arm Swivel	270° / 180° Lockout feature			
VESA	75 x 75 / 100 x 100			
Clamp: Desk Thickness	0 - 45 mm			
Grommet: Desk Thickness / Diameter	10 - 75 mm / 10 - 80 mm			
Tension Adjustment	No	No	Yes	Yes
Weight Capacity: Per Screen (kg)	1 - 9 kg			
Maximum Monitor Size (diagonal)	40" (101.6 cm)			
Maximum Monitor Size (W x H)	94 x 125 cm	145 x 135 cm	104 x 158 cm	154 x 174 cm
Warranty	15 years			

Tallo Modular Triple & Quad Configurations

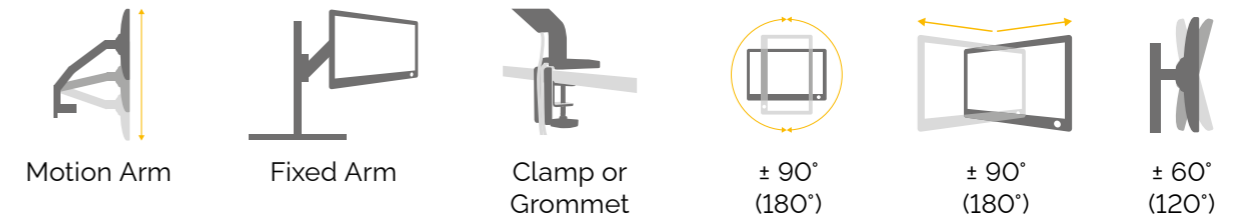

	3FFS	3FMS	4FFS	4FMS
Code	White: 8616701	White: 8616801	White: 8610101	White: 8601401
	Black: 8615701	Black: 8615801	Black: 8610001	Black: 8610301
	Silver: 8614101	Silver: 8614201	Silver: 8610201	Silver: 8610501
Product Dimensions (H x W x D)	155 x 610 x 374 mm	155 x 620 x 365 mm	155 x 620 x 365 mm	100 x 640 x 345 mm
Product Weight	7.3 kg	9.6 kg	15.0 kg	15.4 kg
Height Adjustment Range	267 - 524 mm	267 - 524 mm	250 - 874 mm	112 - 1084 mm
Dynamic Height Adjustability	-	322 mm	-	322 mm
Pole Height	510 mm		721 mm	
Reach Range	120 - 705 mm	120 - 764 mm	120 - 705 mm	120 - 764 mm
Rotation	± 90° (180°)			
Pan	± 90° (180°)			
Tilt	± 60° (120°)			
Arm Swivel	270° / 180° Lockout feature			
VESA	75 x 75 / 100 x 100			
Clamp: Desk Thickness	10 - 85 mm			
Grommet: Desk Thickness / Diameter	10 - 75 mm / 10 - 80 mm			
Tension Adjustments	No	Yes	No	Yes
Weight Capacity: Per Screen (kg)	1 - 9 kg		1 - 7 kg	
Maximum Monitor Size (diagonal)	30" (76.2 cm)	32" (81.2 cm)	40" (101.6 cm)	40" (101.6 cm)
Maximum Monitor Size (W x H)	73 x 102 cm	78 x 102 cm	102 x 57 cm	120 x 67 cm
Warranty	15 years			

Tallo™ Laptop Arm

Effortless integration

Combine with any Tallo arm for a multi-screen set up. Optional ergonomic handle for easy adjustment and quick release plate for seamless installation.



	Tallo Laptop Arm Accessory
Code	White: 8000501
	Black: 8000401
	Silver: 8000601
Product Dimensions (H x W x D)	312 x 242 x 52 mm
Product Weight	2 kg
Weight Capacity (kg)	6 kg
Maximum Laptop Size (diagonal)	18" (45.72 cm)

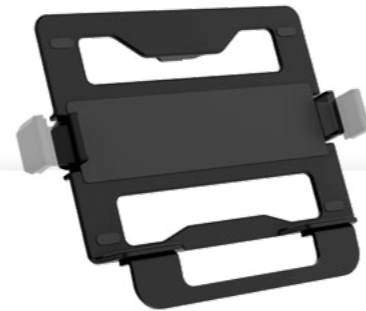

Ergonomic Handle

Optional handle allows for easy repositioning and sharing with colleagues.

Tallo™ FlexCharge Hub

Qi and USB connectivity

Upgrade your Tallo monitor arm with the Tallo Flexcharge Hub.

Featuring Qi wireless charging and easy to access fast charging USB ports, the Flexcharge makes staying connected effortless.



	White	Black	Silver
Code	7502501 (UK) 7502601 (EU)	7502901 (UK) 7503001 (EU)	7503301 (UK) 7503401 (EU)
Product Dimensions (H x W x D)	29 x 165 x 219 mm		
Product Weight	0.5 kg		
Power consumption	12v, 3A		
USB Connectivity	1 x USB Port (Type A) Quick Charge 5V – 12V, 2.4A 1 x USB Port (Type C) Quick Charge 5V – 12V, 2.4A		
Wireless charging	Qi compatible smartphone only 5V, 2A, 10 Watts		
Warranty	5 years		



Eppa™

Enjoy seamless fluidity

Beneath the Eppa's minimal design is a reliable and smooth gas spring adjustment control. This allows the user to effortlessly adjust the height and position of their monitors. The Eppa range of monitor arms offers a comfortable viewing distance regardless of the depth of your desk top.

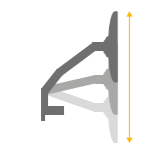

Motion Arm



Clamp or Grommet



± 90° (180°)

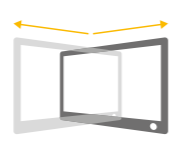

± 90° (180°)



+ 90° / - 25° (115°)

Effortless Motion

Finger touch gas spring adjustment helping you to reduce eye, neck and back strain and work in comfort.

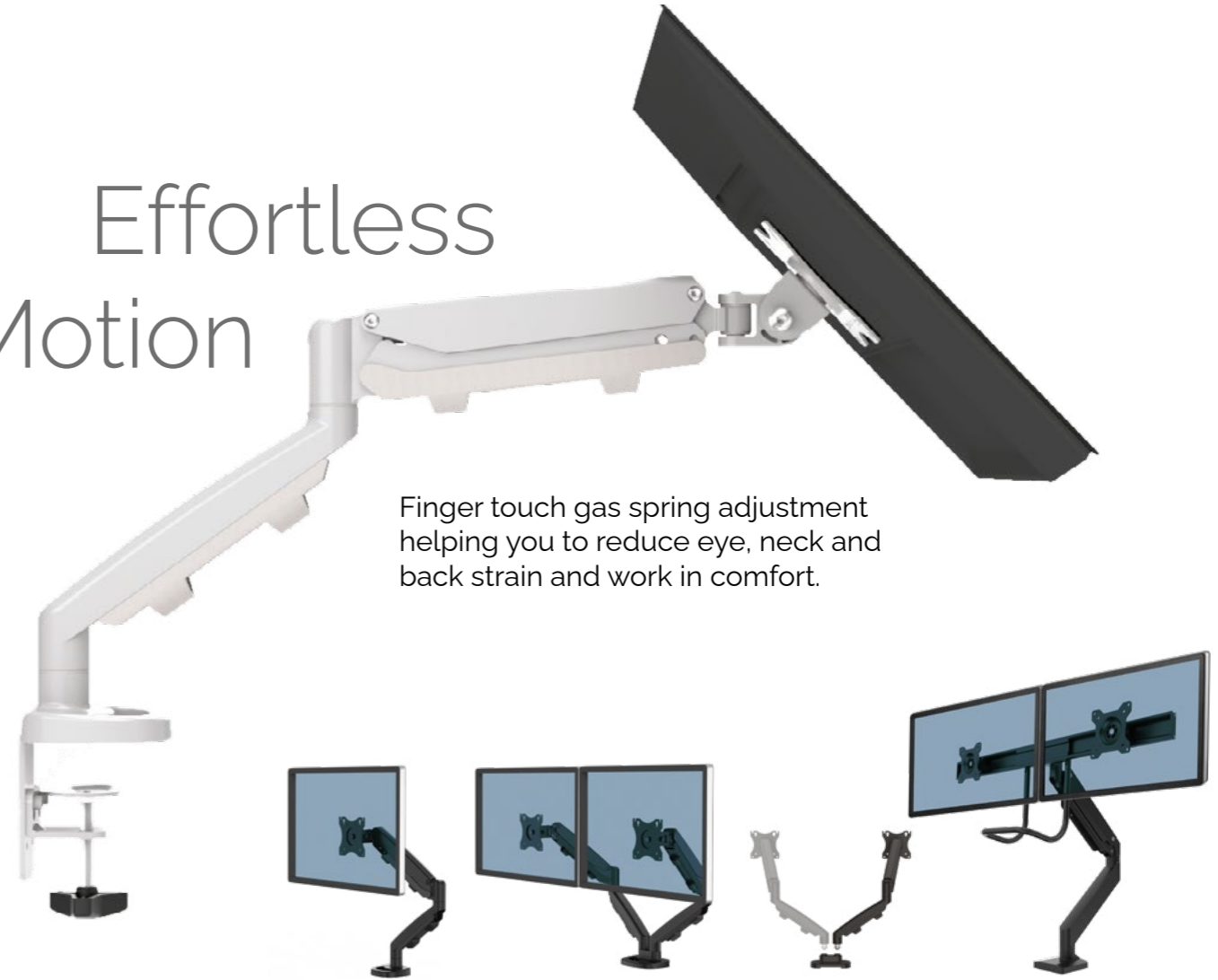

	Single	Dual	Dual Kit	Cross Bar
Code	White: 9683201	White: 9683501	White: 9683801	White: 9909401
	Black: 9683101	Black: 9683401	Black: 9683601	Black: 9909301
	Silver: 9683001	Silver: 9683301	Silver: 9683701	Silver: 9909201
Product Dimensions (H x W x D)	480 x 117 x 565 mm	480 x 1000 x 565 mm	480 x 117 x 565 mm	830 x 726 x 46 mm
Product Weight	3.0 kg	5.1 kg	3.2 kg	7.2 kg
Height Adjustment Range	133 - 415 mm			251 - 601 mm
Dynamic Height Adjustability	282 mm			350 mm
Reach Range	67 - 537 mm			103 - 629 mm
Rotation	± 90° (180°)			
Pan	± 90° (180°)			±10° (20°)
Tilt	+ 90° / - 25° (115°)			±10° (20°)
Arm Swivel	360°			360° / 180° Lockout feature
VESA	75 x 75 / 100 x 100			
Clamp: Desk Thickness	10 - 85 mm			
Grommet: Desk Thickness / Diameter	10 - 85 mm / 8 - 82 mm			10 - 85 mm / 10 - 48 mm
Tension Adjustment	Yes			
Weight Capacity: Per Screen (kg)	1 - 8 kg			
Maximum Monitor Size (diagonal)	40" (101.6 cm)			32" (81.2 cm)
Maximum Monitor Size (W x H)	99 x 829 cm			76 x 1201 cm
Warranty	5 years			

Platinum

Powerful flexibility

A wide choice of multi-screen modes with USB connectivity. Maximise productivity with the hard-working Platinum range.

Flexible movement

This gas spring arm makes it easy for the user to position the monitors in the right position for them.

Wide choice

Choose between 1, 2 or 3 monitors with dual stacking and side by side set ups, in a variety of colours to suit multiple user requirements.

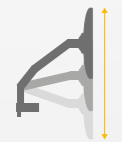

Motion Arm



Clamp or Grommet



360°

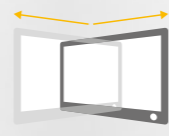

± 90°
(180°)



± 45°
(90°)



Built-in connectivity and cable management

Save desk space with built in USB 3 connectivity to charge devices and intuitive cable management.

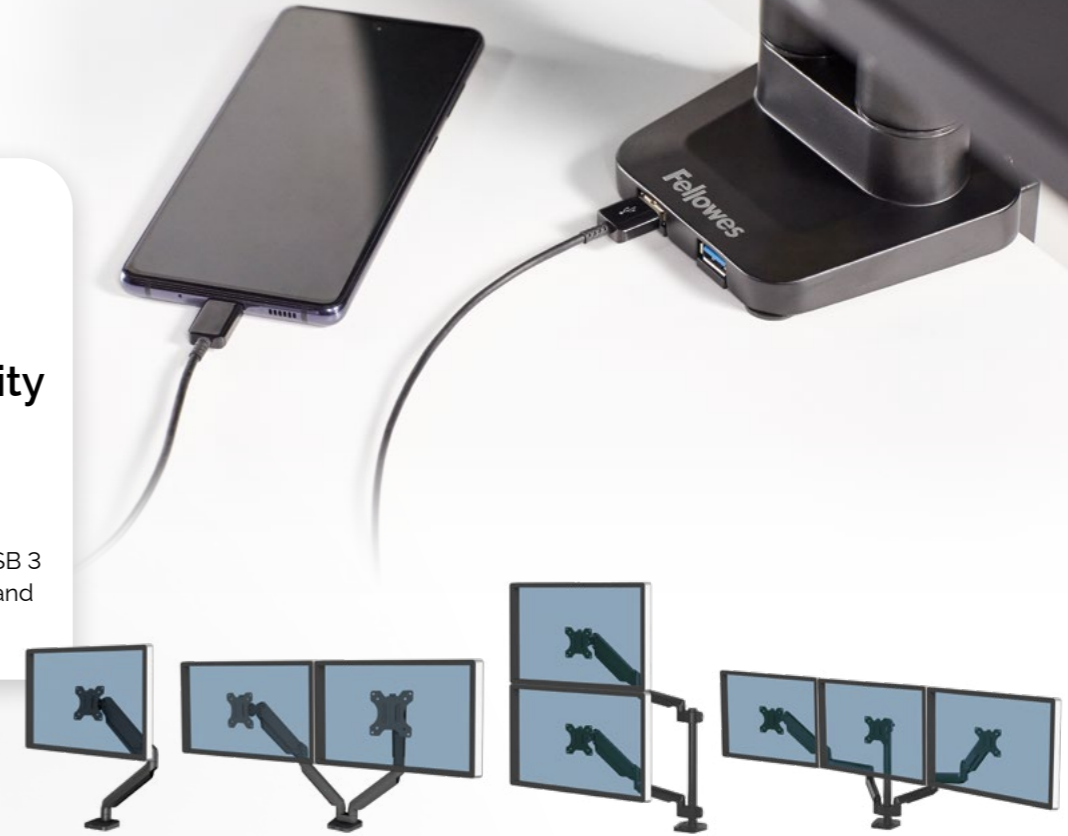

	Single	Dual	Dual Stacking	Triple
Code	Black: 8043301	Black: 8042501	Black: 8043401	Black: 8042601
	White: 8056201	White: 8056301	-	-
	Silver: 8056401	Silver: 8056501	-	-
Product Dimensions (H x W x D)	590 x 114 x 495 mm	590 x 949 x 114 mm	886 x 103 x 115 mm	924 x 1275 x 141 mm
Product Weight	2.7 kg	5.1 kg	5.0 kg	7.8 kg
Height Adjustment Range	135 - 415 mm	135 - 415 mm	57 - 717 mm	135 - 435 mm
Dynamic Height Adjustability	280 mm			
Pole Height	-	-	458 mm	458 mm
Reach Range	63.5 - 505mm	63.5 - 505mm	63.5 - 565 mm	102 - 705 mm
Rotation	360°			
Pan	± 90° (180°)			
Tilt	± 45° (90°)			
Arm Swivel	360°			
VESA	75 x 75 / 100 x 100			
Clamp: Desk Thickness	10-85 mm			
Grommet: Desk Thickness / Diameter	10 - 85 / 8.5 - 70 mm			
Tension Adjustment	Yes			
USB Connectivity	2 x 3.0 USB Port 0.5A (Type A)			
Weight Capacity: Per Screen (kg)	1.5 - 8 kg	1.5 - 8 kg	1.5 - 8kg	1.5 - 7 kg
Maximum Monitor Size (diagonal)	32" (81.2 cm)	32" (81.2 cm)	Stacking: 27" (68.50 cm) Side by side: 32" (81.28 cm)	27" (68.50 cm)
Maximum Monitor Size (W x H)	83 cm (H)	94 x 83 cm	Stacking: 72 cm (H) Side by side: 102 cm (W)	69 x 87 cm
Warranty	3 years			

Balanced control

Accessible design with easier adjustment. Practical performance for everyday use. Better quality fixed arms with specialist ergonomic design.

Flexible movement

Mounted fixed arm options that are easier to install and reposition with the tool-free height adjustment.

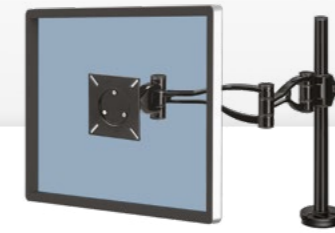
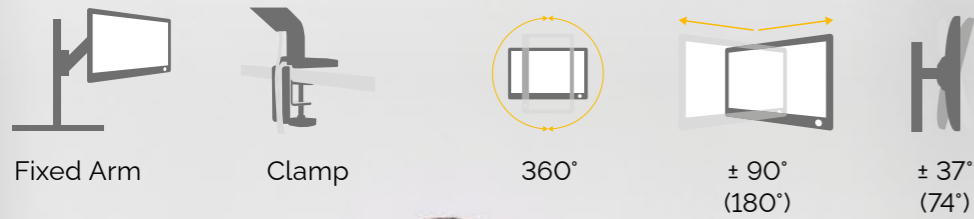

Vista Single Monitor Arm

Exclusive design, supported with clear instructions.



Vista Dual Monitor Arm

Make teamwork easier when you can quickly reposition your screen.

	Single	Dual
Code	8041601	8041701
Product Dimensions (H x W x D)	533 x 111 x 610 mm	559 x 111 x 984 mm
Product Weight	3.43 kg	4.58 kg
Height Adjustment Range	85 - 406 mm	
Pole Height	420 mm	
Reach Range	115 - 556 mm	115 - 552 mm
Rotation	360°	
Pan	± 90° (180°)	
Tilt	± 37° (74°)	
Arm Swivel	180°	
VESA	75 x 75 / 100 x 100	
Clamp: Desk Thickness	0 - 76 mm	
Weight Capacity: Per Screen (kg)	10 kg	
Maximum Monitor Size (diagonal)	32" (81.2 cm)	26" (66 cm)
Maximum Monitor Size (W x H)	81 cm (H)	100 x 81 cm
Warranty	3 years	



Vista Laptop arm accessory

Attach your laptop to a Vista laptop arm accessory to increase desk space and position your laptop ergonomically, reducing eye, neck and shoulder strain.

	Vista Laptop Arm Accessory
Code	8211901
Product Dimensions (H x W x D)	85 x 330 x 320 mm
Product Weight	2.30 kg
Weight Capacity (kg)	4.5 kg
Maximum Laptop Size (diagonal)	17" (43.1 cm)
Warranty	3 years

Reflex™

Greater freedom

Entry-level and affordable option that is mounted for space saving and added adjustability.

Save desk space

Mounted range frees up desk space. Monitor depth can be easily re-positioned to suit you.



Fixed Arm



Clamp or Grommet



360°



± 90°
(180°)



± 45°
(90°)



Reflex Single Monitor Arm

Practical adjustment and everyday comfort.

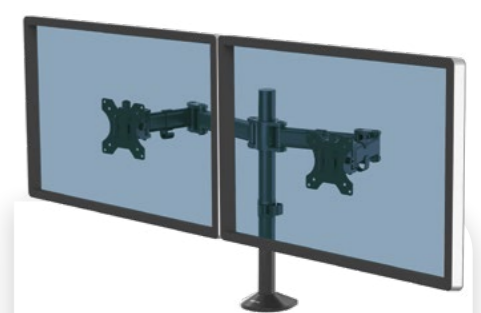

Reflex Dual Monitor Arm

Experience greater freedom and space to thrive.



	Single	Dual
Code	Black: 8502501	Black: 8502601
Product Dimensions (H x W x D)	550 x 116 x 490 mm	550 x 116 x 726 mm
Product Weight	3.0 kg	4.2 kg
Height Adjustment Range	58 - 416 mm	
Pole Height	450 mm	
Reach Range	63.5 - 422 mm	63.5 - 387 mm
Rotation	360°	
Pan	± 90° (180°)	
Tilt	± 45° (90°)	
Arm Swivel	180°	
VESA	75 x 75 / 100 x 100	
Clamp: Desk Thickness	10 - 88 mm	
Grommet: Desk Thickness / Diameter	10 - 75 mm / 10.5 - 70 mm	
Weight Capacity: Per Screen (kg)	8 kg	
Maximum Monitor Size (diagonal)	32" (81.2 cm)	27" (68.5 cm)
Maximum Monitor Size (W x H)	83 cm (H)	73 x 83 cm
Warranty	3 years	

Seasa™

Pure simplicity

Practical adjustment for everyday comfort.



Fixed Arm

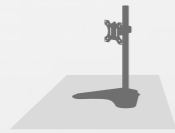

Freestanding



360°



± 60°
(120°)



± 45° (90°)
Dual: ± 30° (60°)



Seasa Single Monitor Arm

Position your monitor arm wherever you like.

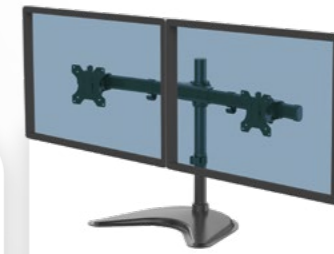

Seasa Dual Monitor Arm

Increase your productivity with dual screen working.



Seasa Dual Stacking Monitor Arm

Think clearer when you raise your screen and free your desk space.



	Single	Dual	Dual Stacking
Code	Black: 8049601	Black: 8043701	Black: 8044001
Product Dimensions (H x W x D)	465 x 390 x 280 mm	465 x 805 x 316 mm	902 x 389 x 279 mm
Product Weight	2.67 kg	4.87 kg	4.08 kg
Height Adjustment Range	83 - 445 mm	76 - 435 mm	83 - 885 mm
Pole Height	465 mm	465 mm	905 mm
Rotation		360°	
Pan		± 60° (120°)	
Tilt	± 45° (90°)	± 30° (60°)	± 45° (90°)
VESA		75 x 75 / 100 x 100	
Weight Capacity: Per Screen (kg)		8 kgs	
Maximum Monitor Size (diagonal)	32" (81.2 cm)	27" (68.5 cm)	32" (81.2 cm)
Maximum Monitor Size (W x H)	89 (H) cm	70 x 87 cm	59 (H) cm
Warranty		3 years	

Laptop Arm Accessory

Stay **focused** and **flexible**

Combine with any Fellowes monitor arm for a multi screen set up.



	Laptop Arm Accessory
Code	Black: 8044101
Product Dimensions (H x W x D)	279.4 x 442.9 x 65.1 mm
Product Weight	1.18 kg
Weight Capacity (kg)	4.5 kg
Maximum Laptop Size (diagonal)	17" (43.1 cm)



Laptop Arm Accessory
Adjustable brackets keep your laptop secure.

Compatible with all Fellowes monitor arms excluding the Vista range (8041601/8041701).

Wall Mount

Maximise space

Full motion monitor arms easily extend & retract for TV screens or monitors up to 35kgs.



Single Wall Mount Arm
Gas spring movement.

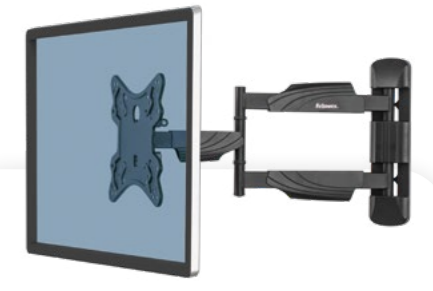

Full Motion Wall Mount Arm
Depth adjustable.

	Single Wall Mount Arm	Full Motion Wall Mount Arm
Code	Black: 8043501	Black: 8043601
Product Dimensions (H x W x D)	478 x 225 x 514 mm	454 x 413 x 502 mm
Product Weight	3.54 kg	2.72 kg
Dynamic Height Adjustability	282 mm	-
Reach Range	59 - 563 mm	495 mm
Rotation	± 3° (6°)	± 5° (10°)
Pan	± 90° (180°)	± 90° (180°)
Tilt	+15°/-5° (20°)	+2°/-12° (14°)
Arm Swivel	180°	180°
VESA	75 x 75 / 100 x 100 / 200 x 200 / 200 x 100	100 x 100 / 100 x 150 / 200 x 100 / 200 x 200 / 300 x 300 / 300 x 200 / 400 x 400 / 400 x 300 / 400 x 200
Weight Capacity: Per Screen (kg)	5 - 30 kg	35 kg
Maximum Monitor Size (diagonal)	42" (51 - 107 cm)	23" - 55" (58 - 140 cm)
Warranty	3 years	

Fellowes

For further information contact:

E: interiors@walters.co.uk

T: 01733 707116

walters.